

REV.	ECN NO.	LOCATIONS	DESCRIPTION	DATE	DESIGN
N1			NEW RELEASE	03/19'26	Sun

CUSTOMER DRAWING
RoHS Compliant

ORDERING INFORMATION

MCCFT -Z1K2 (XX T)

① ② ③

① **PRODUCT SERIES:**

USB C TYPE connector -
Receptacle (Female) side.

② **ITEM NO.:**

Right Angle- Single Row SMD 16pin
Sink1.0/ Body 6.5L

③ **GOLD PLATING :**

01: G/F.
03: 3u".
15: 15u".
30: 30u".

3D VIEW

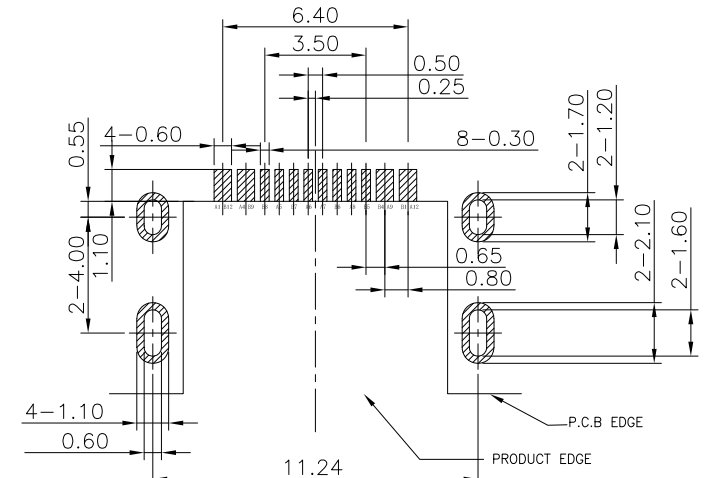
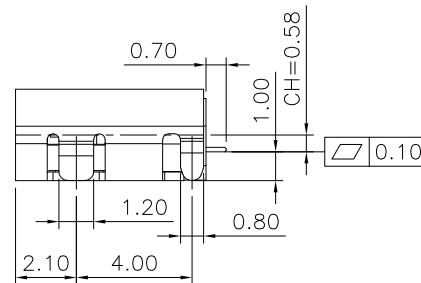
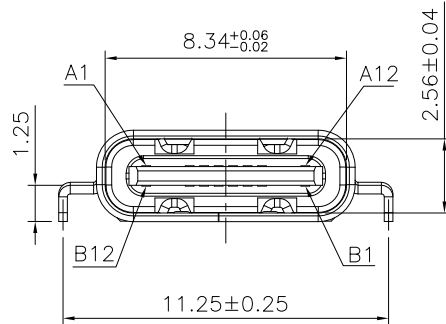
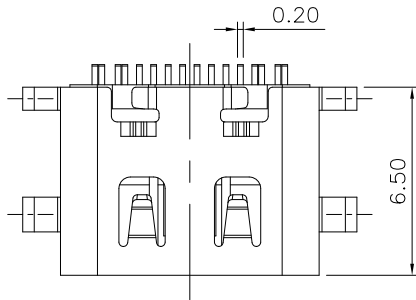
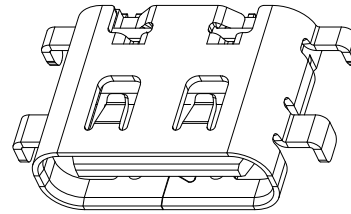

RECOMMENDED PCB LAYOUT
GENERAL TOLERANCE: ±0.05

NOTES:

- MATERIAL:**
 - HOUSING: HIGH TEMP plastic, UL94 V-0.
 - CONTACT: COPPER ALLOY.
 - MID PLATE: STAINLESS STEEL.
 - SHELL: STAINLESS STEEL.
- PLATED:**
 - CONTACT: GOLD ON CONTACT AREA OVER NICKEL PLEATED OVER ALL.
 - SHELL: NICKEL PLATED OVER ALL.
 - MID PLATE: CLEAR ONLY
- MECHANICAL PERFORMANCE,**
 - INSERTION FORCE: 5~20N.
 - REMOVAL FORCE: 8~20N.
 - DURABILITY: 10,000 CYCLES.
- ELECTRICAL PERFORMANCE,**
 - CURRENT RATING: 5.0A
 - VOLTAGE RATING: 20V
- ENVIRONMENTAL PERFORMANCE:**

OPERATING TEMPERATURE: -40°C~+85°C.

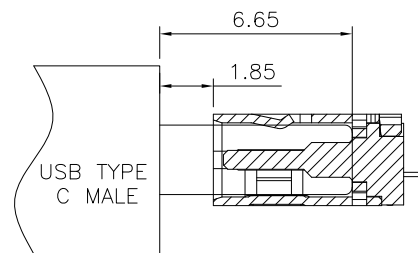
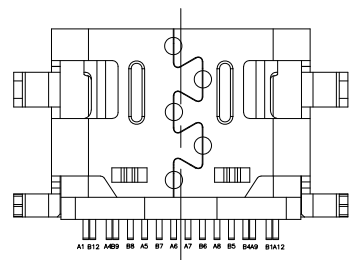

PIN ASSIGNMENTS

PIN NO.	A1	A4	A5	A6	A7	A8	A9	A12
SIGNAL NAME	GND	VBUS	CC1	Dp1	Dn1	SBU1	VBUS	GND
PIN NO.	B12	B9	B8	B7	B6	B5	B4	B1
SIGNAL NAME	GND	VBUS	SBU2	Dn2	Dp2	CC2	VBUS	GND

DIM	TOL
x.x	±0.30
x.xx	±0.20
x.xxx	±0.10

SUNFUN		SUNFUN TECHNOLOGY LTD			
DRAW NO.	MCCFT-Z1K2(A0)	DATE	03/19'26	MATERIAL:	SEE NOTES
DESIGN:	Sun	03/19'26	FINISH:	SEE NOTES	DRAW NAME:
CHECK:	Sun	03/19'26	FILE:	MCCFT-Z1K2(A0)	USB C Type CONN - FEMALE Right Angle- Single Row SMD 16pin Sink1.0 /Body 6.5L
REVIEW:	Rui	03/19'26	P/N:	MCCFT-Z1K2(XXT)	MODEL: USB C TYPE CONN
APPROVED	Rui	03/19'26	REV. N1	SCALE	UNIT: mm
					SHEET: 1/1